

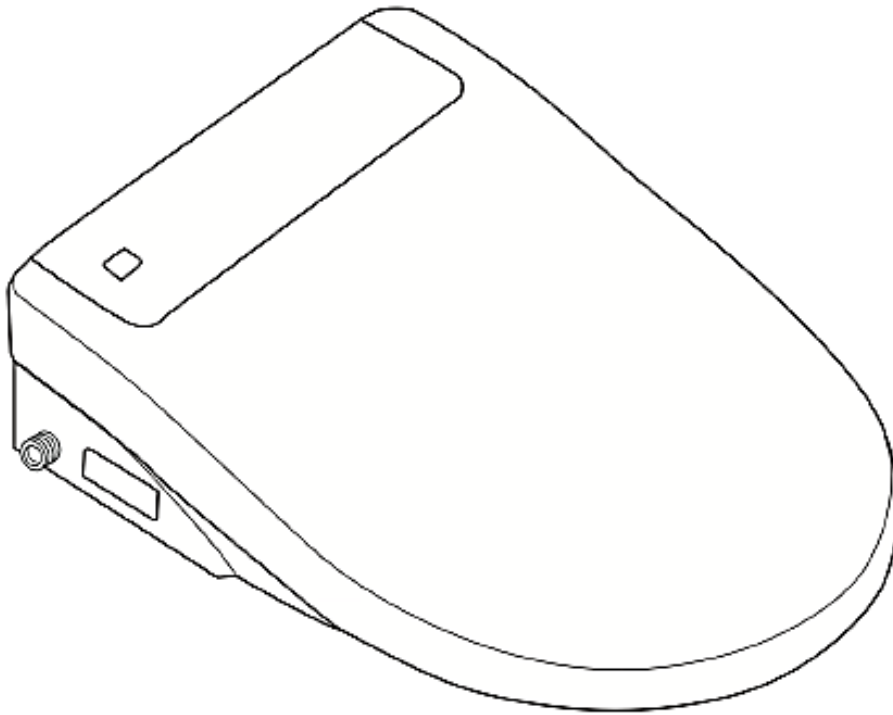

my luxury loo



Smart Bidet Attachment

Installation Manual

- Thank you for choosing our products. Please read the instructions carefully before installation and keep it available for future maintenance or reference.
- Our company reserves the right of final interpretation for this manual.
The manual is subject to change without notice.

Please also see website for downloadable version of this manual at
www.myluxyloo.com

Content

Introduction	Important Safeguards -----	01
	Technical specification -----	03
	List packing -----	04
	Parts identification -----	05
Operation	Installation instructions -----	06
	1.Installation dimensions	
	2.Installation of mounting plate	
	3.Installation and disassembly of main unit	
	4.Connecting the water supply pipe	
Usage instruction -----	08	
1.Checking the power and water supply		
2.Function illustration of keys in main unit		
3.Function illustration of keys in remote-control and LCD display instruction		
Daily maintenance -----	10	
1.Main unit maintenance		
2.Spray nozzle maintenance		
3.Inlet filter cleaning		
4.Tank anti-freezing and anti-bacterial maintenance		
Troubleshooting Guide -----	12	
Others	Warranty card -----	12

IMPORTANT SAFEGUARDS

When using electrical products, especially when children are present, basic safety precautions should always be followed, including the following:

1. The appliance is not to be used by persons (including children) with reduced physical, sensory or mental capabilities, or lack of experience and knowledge, unless they have been given supervision or instruction.
2. This appliance can be used by children aged from 8 years and above and persons with reduced physical, sensory or mental capabilities or lack of experience and knowledge if they have been given supervision or instruction concerning use of the appliance in a safe way and understand the hazards involved.
3. Children shall not play with the appliance.

READ ALL THE INSTRUCTIONS BEFORE USING



DANGER – To reduce the risk of electrocution:

1. Do not use while bathing
2. Do not place or store product where it can fall or be pulled into a tub or sink.
3. Do not place in or drop into water or other liquid.
4. Do not reach for a product that has fallen into water. Unplug immediately.
5. Do not wash the main unit or electrical plug with water or detergent.
6. Do not handle the electrical plug with wet hands.
7. Never put your hand or anything else blocking the air dryer outlet.
8. Never disassemble, repair or modify this product.
9. During installation, disassembly, repair and maintenance of the product, the power must be unplugged and water supply be shut off.



WARNING – To reduce the risk of burns, electrocution, fire, or injury to persons:

1. Close supervision required for use by children and people with impairments that may prevent them from getting up or recognizing that there may be an issue.
2. Use this product only for its intended use as described in this manual. Do not use attachments not recommended by the manufacturer.
3. Never operate this product if it has a damaged cord or plug, if it is not working properly, if it has been dropped or damaged, or dropped into water. Return the product to for examination and repair.
4. Keep the cord away from heated surfaces.
5. Never use while sleeping or drowsy.
6. Never drop or insert any object into any opening or hose.
7. Do not use outdoors or operate where aerosol (spray) products are being used or where oxygen is being administered.
8. Connect this product to a properly grounded outlet only. See Grounding Instructions.
9. Do not throw cigarettes, ash, or anything burning into the toilet.
10. Avoid any splashing or spraying from outside sources and wipe off immediately if the bidet gets wet.
11. Do not lay on side or on it's top.
12. It is prohibited to use other electric appliances in the same socket.
13. It is forbidden to use the power extension or unstable loose outlet.
14. Ensure there is no leaking or dripping from loose connections or an old water line.



IMPORTANT SAFETY INSTRUCTIONS



CAUTION – Indicates that failure to follow the instruction may cause body injury or property damage

1. Do not install or use the product in wet places such as a steam room etc.
2. It is recommended to use a water-proof electrical outlet which should be installed where it cannot easily get wet.
3. This product should be used with 110V-120V,50/60Hz electrical current only, load current is at least 15A. Power plug must be equipped with ground fault circuit interrupter or ground fault electrical leakage protector or a similar high sensitive, rapid type leakage switch (Rated sensitive current under 6mA).
4. When it thunders, it is strongly recommended to pull out the power plug.
5. Do not stand on a ceramic toilet.
6. Ceramic toilet must be installed to the floor with a fixing bolt.
7. Do not stand on product unit, seat and cover.
8. Do not lean against the seat cover when using the product, to avoid damage.
9. This product is equipped with soft-closing seal cover. Heavy pressing or pushing may damage the soft-closing damper.
10. Do not use lacquer thinner, petrol, liquid medicine, detergent, insecticide, toilet cleanser and scrubbing brush to clean the product.
11. Exposure to direct sunlight is prohibited.
12. Only use tap or potable water when wiping down the bidet
13. Do not connect water supply to heater outlet. Ensure inlet water temp is between 35-95 degrees Fahrenheit.
14. When the room temperature is under zero degree, please dry up the water tank, to avoid freezing.
15. Raise restroom temperature to prevent the toilet from being damaged due to freezing.
16. When moving the product from a cold or wet environment into normal room temperature, wait for 2 hours until the condensation is gone. Doing so can prevent the product from having an electrical short-circuit.
17. When not using the product over three (3) days, drain the water out of the container and pull the electrical plug from the wall outlet.
18. Stop using the product and shut off the power when product malfunctions, please contact us for help.

GROUNDING INSTRUCTIONS

This product should be grounded. In the event of an electrical short circuit, grounding reduces the risk of electric shock by providing an escape wire for the electric current. This product is equipped with a cord that has a grounding wire with a grounding plug. The plug must be plugged into an outlet that is properly installed and grounded.



DANGER – Improper use of grounding plug can result in a risk of electric shock

If repair or replacement of the cord or plug is necessary, do not connect the grounding wire to either flat blade terminal. The wire with insulation with an outer surface that is green with or without yellow stripes is the grounding wire.

This product is factory equipped with a specific electric cord and plug to permit connection to a proper electric circuit. Make sure that the product is connected to an outlet having the same configuration as the plug. No adapter should be used with this product. Do not modify the plug provided — if it will not fit the outlet, have the proper outlet installed by a qualified electrician. If the product must be reconnected for use on a different type of electric circuit, the reconnection should be made by qualified service personnel.

SAVE THESE INSTRUCTIONS





Technical Specification

Main Unit	Rating pressure	110 -120V, 50/60Hz
	Rating power	1050-1250W
	Water pressure range	Minimum water pressure 0.07MPa (20L/min. flowing pressure). Maximum water pressure 0.8MPa (Hydrostatic pressure)
	Electrical wire	Length is 1.5m (5')
Cleaning device	Container capacity	600ml
	Heating power	1000W
	Water temperature	6 different level adjustments
	Water volume	5 different level adjustments
	Cleansing mode	Rear cleaning/Rear massage, Front cleaning for ladies
	Spray nozzle location	5 different level adjustments
	Water pressure protector	Pressure stabilizer, Automatic pressure discharging
	Anti-fouling device	Speedy water discharge device, Automatic nozzle cleaning, Anti-syphon device, Anti-backflow device, Filter device
Drying device	Safety device	Temperature controller, Thermal fuse, Ground protection, Leakage protection device, Air burning preventer
	Warm air speed	Over 4 m/s
	Warm air temperature	6 different level adjustments
	Heating power	250W
Heated seat	Safety device	Temperature sensor, Temperature controller, Thermal fuse
	Surface temperature	6 different level adjustments
	Heating power	50W
	Open and close device	Quiet soft-closing device
	Heated burning protection	The seat temperature will automatically lower to level 1 in 10 minutes after use
Intelligent	Safety device	Seat sensor, Temperature sensor, Temperature controller, Thermal fuse
	Night light assembly	Intelligent, often in the off state
	Mute setting	Buzzer off during night
	User ID setting	To avoid disturbance from remote controls by multi-user

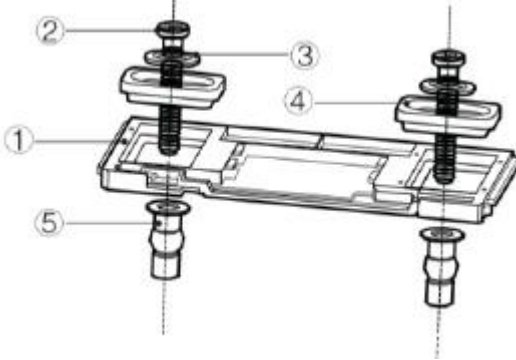
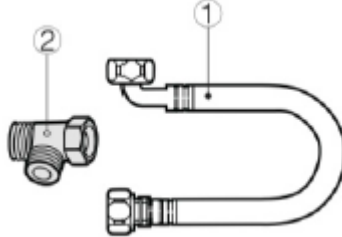

Packaging List

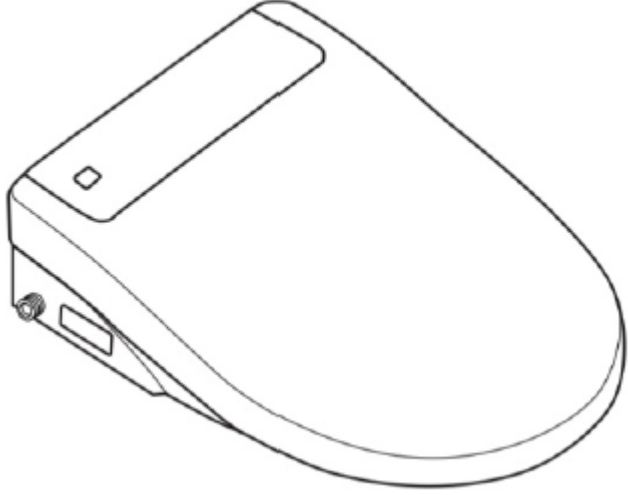
<p>Remote Control Panel Parts</p>		 <p>The appearance and function of the remote control are subject to the actual product</p>
<p>Base Plate Parts</p>	<p>① Base plate</p> <p>② Bolt (2pcs)</p> <p>③ Flat Washer (2pcs)</p> <p>④ Plastic Plate (2pcs)</p> <p>⑤ Expansion Nut (2pcs)</p>	
<p>Water Supply Assembly</p>	<p>① Water Inlet Hose (1pcs)</p> <p>② 3-way Connector (1pcs)</p>	
<p>Installation Manual</p> <p>Warranty Card</p> <p>Installation paperboard</p>	<p>Installation Manual</p> <p>Warranty Card</p> <p>Installation paperboard</p>	
<p>Main Unit</p>		

Main Unit Identification

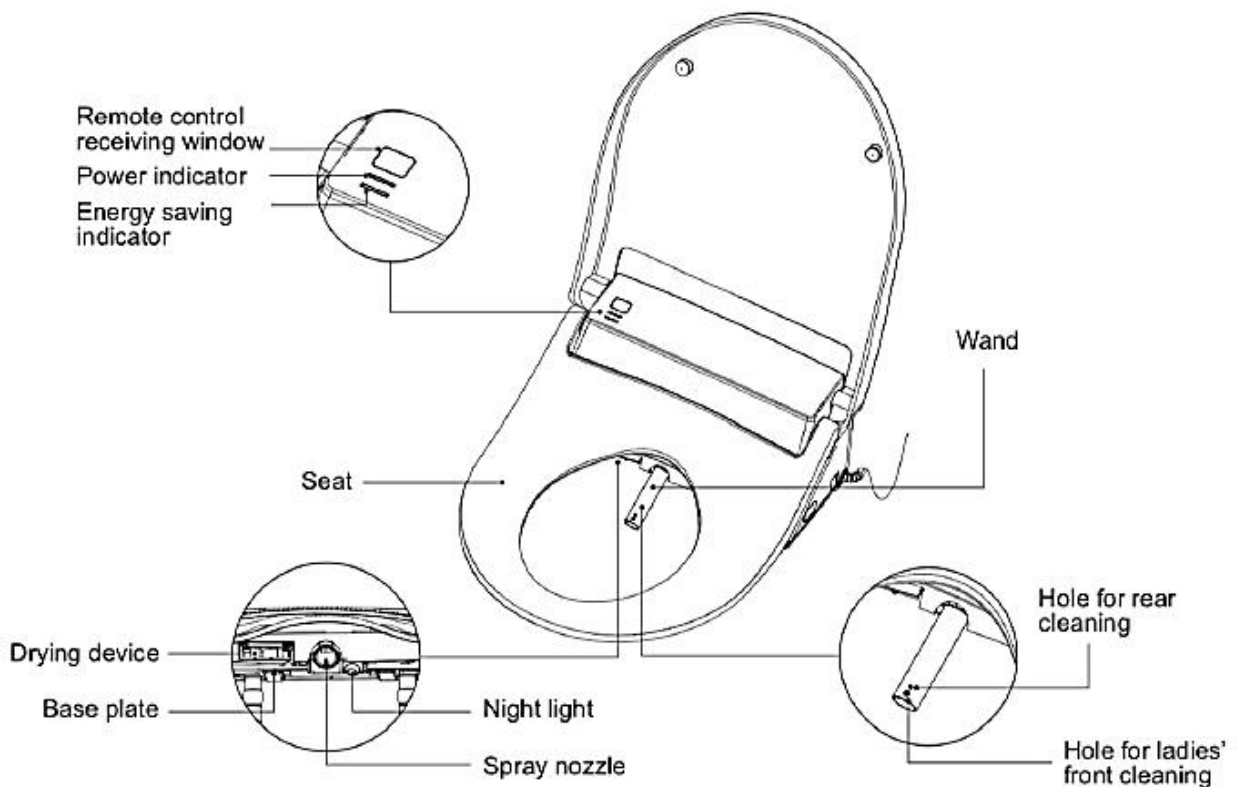
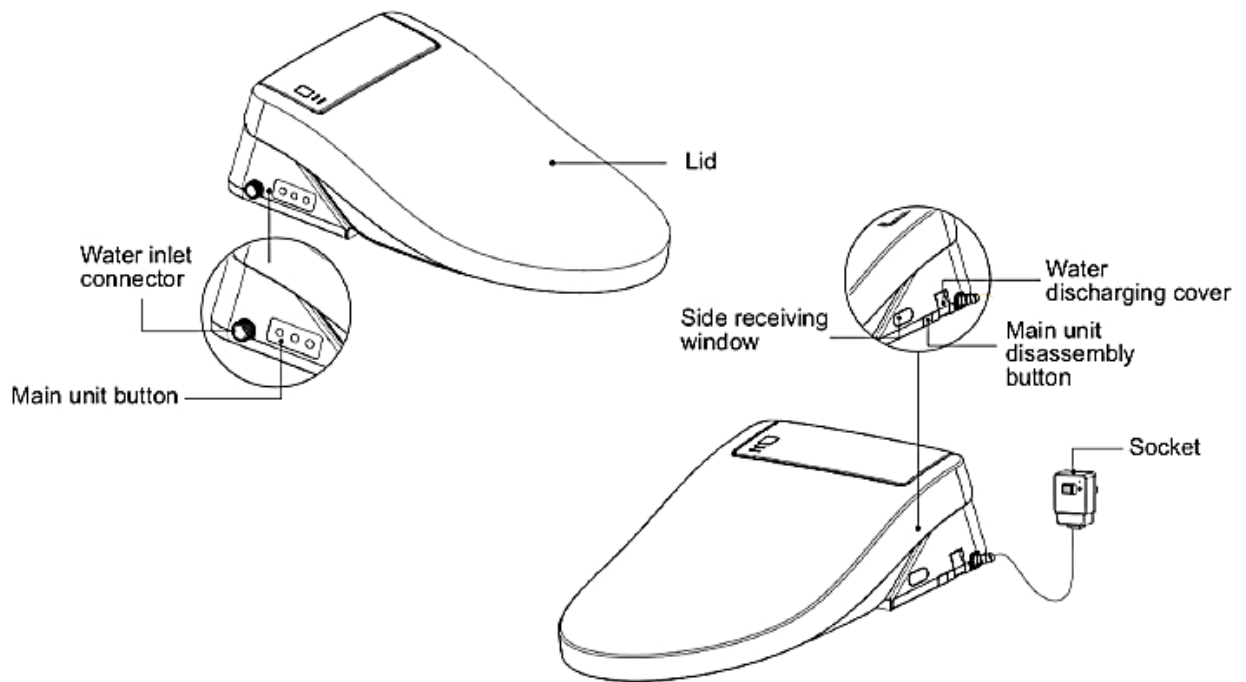

Installation Instruction

***REFERENCE VIDEO ON WEBSITE. WATCH BEFORE INSTALLING

Installation dimension

Note: please check that the installation dimensions match the user's toilet.

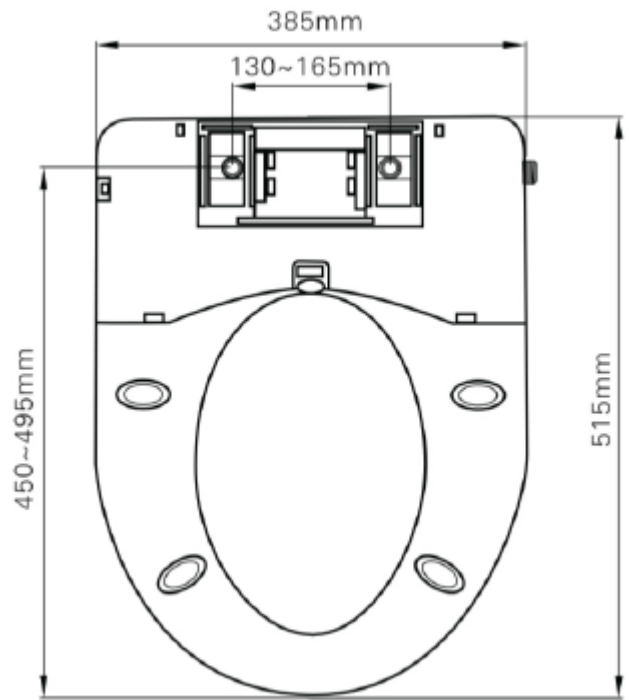

Installation of mounting plate

Press the expansion nuts into the installation holes in the toilet, then install the base plate, plastic plates, flat washers and bolt as per the drawing and tighten the bolts.

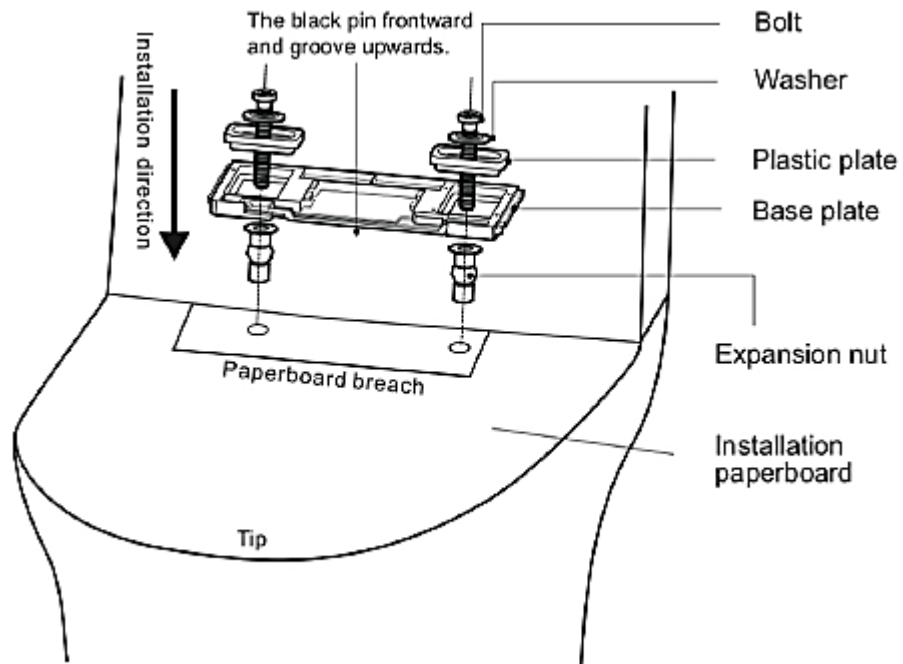

Note:

Unfold the installation paperboard, align the paperboard to fit the bowl from the tip, and then insert base plate to align with paperboard breach.

Installation and disassembly of main unit

Installation

Push the washlet back onto the base plate until a “click” is heard.



Installation

Disassembly

Press the “removal button” on the bidet, until a “click” is heard, and pull it out.

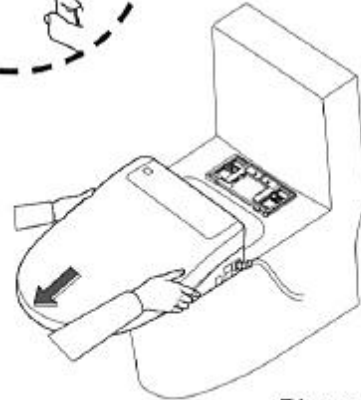
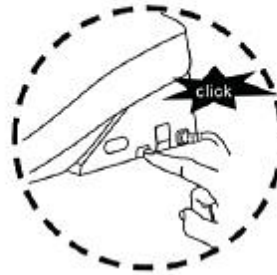

Disassembly

Note:

Before pulling out the washlet, release hand from “removal button”.

Connecting the water supply pipe

1. Turn off the angle valve to shut off water to toilet.
2. Flush toilet to remove excess water and pressure.
3. Remove water supply line from the water tank and connect the 3-way connector between the hose and the tank. Keep a towel or pan nearby to catch any excess water.
4. Connect the white water supply line to the 3-way connector and connect the L-shaped end of the inlet hose to the bidet inlet connector on the bidet attachment.
5. Make sure all of the connections are connected straight on and tightened well to prevent leakage.

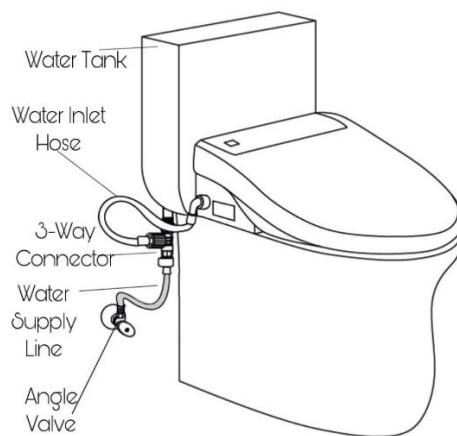





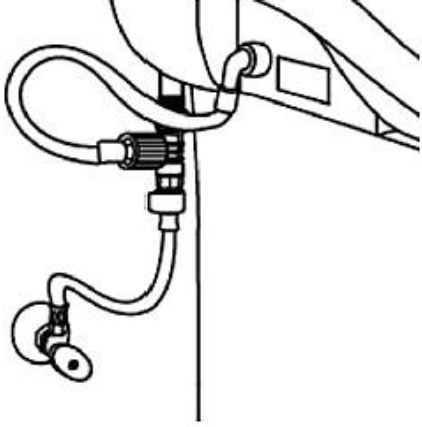
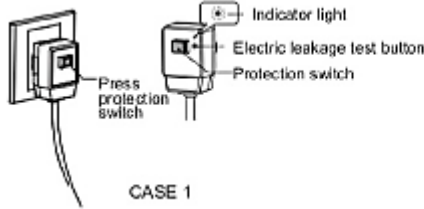
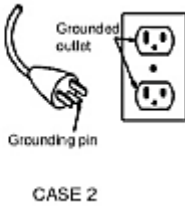
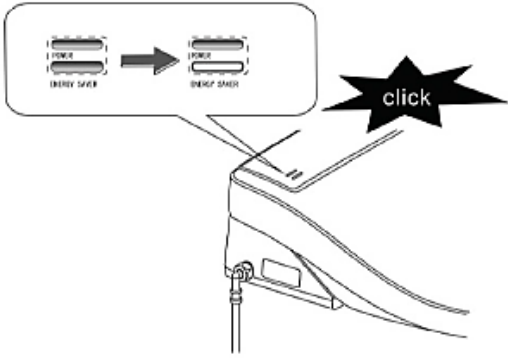
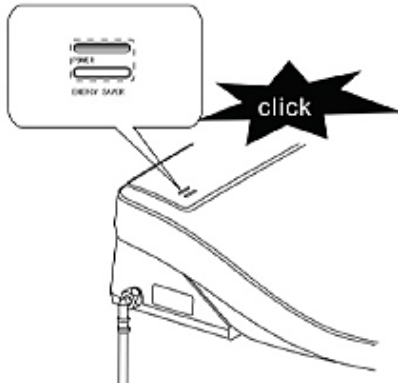
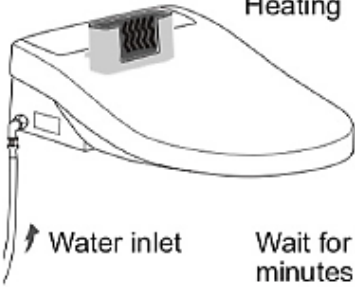

Note:

Do not distort or damage the supply hose to avoid any leakage.
Do not use a water supply hose or other accessories of other brands, which may cause danger.
Do not recommend to use our old water supply hose and accessories, which may cause danger.



Usage Instruction

Checking the power and water supply	
<p>Connect the water supply hose and turn on the angle valve. Check for any leakage.</p>	<p>Insert power plug into power socket.</p>
	<div style="display: flex; justify-content: space-around;"> <div style="text-align: center;">  <p>CASE 1</p> </div> <div style="text-align: center;">  <p>CASE 2</p> </div> </div> <p>NOTE: If it's an electric leakage protection plug, press protection switch, indicator is on which means there is electricity. Press electric leakage test button prior to usage, protection switch bounces to show that protection function works normally.</p> <p>NOTE: If its not an electric leakage protection plug, insert power plug into power socket directly.</p>
<p>The main unit buzzer makes a "click", the power light and energy saver light will flash. Power light on and energy saver light off means self-inspection is occurring.</p>	<p>The buzzer makes a second "click" to show that self-inspection is finished</p>
	
<p>The water starts to flow into tank and heating will take 3 minutes.</p>	
<div style="display: flex; align-items: center;"> <div style="text-align: center;">  <p>Heating</p> <p>Water inlet</p> </div> <div style="margin-left: 20px;"> <p>Wait for 3 minutes</p>  </div> </div>	

Function illustration of keys in main unit and actuator		
	 Power	<ol style="list-style-type: none"> 1. Press and hold "Power" button to enter standby mode; and then quickly press "Power" button to restore functional mode. 2. When sitting, press "Power" button to stop the cleaning or drying. When no one is sitting, press "Power" button to switch between function mode and power save mode
	 Front cleaning button	<p>When sitting, press "Front cleaning" button, it will clean the front portion of body; press "Front cleaning" button again or "Power" button, the function will be finished. After a cycle, this function will be finished automatically, if people keep sitting, it will automatically switch to drying function, and will stop after a cycle.</p>
	 Rear cleaning button	<ol style="list-style-type: none"> 1. When sitting, press "Rear cleaning" button, it will clean the rear portion of body; repress "Front cleaning" button or "Power" button, the function will be finished. After a cycle, this function will be finished automatically, if people keep sitting, it will switch to drying function, and will stop after a cycle. 2. When no one is sitting, press "Rear cleaning" button, then the wand will stretch out to clean the nozzle and spray wand.

NOTE:

1. When the unit is in functional mode, the power light goes on and energy saver light goes off; When in energy save mode, the power light goes off, and energy saver light goes on; When in standby mode, both lights are off.
2. The default setting of all functions is on the middle level, after using the remote-controller, shift to the level showing on remote-controller.
3. If the product is not used for continual 72 hours, the water in the tank will automatically discharge for 90 seconds and will be replaced by fresh water, to avoid bacteria.

Function illustration of keys in remote-control and LCD display instruction
<ul style="list-style-type: none"> • The operating method of remote control shows in instruction manual.



Daily maintenance

Main unit maintenance

1. Shut off power supply during maintenance.
2. Turn the seat upward open, press down the button located on the right side of main unit and pull out the seat. Wipe any stains with a soft damp cloth.
3. After cleaning, re-install the seat onto the bracket.

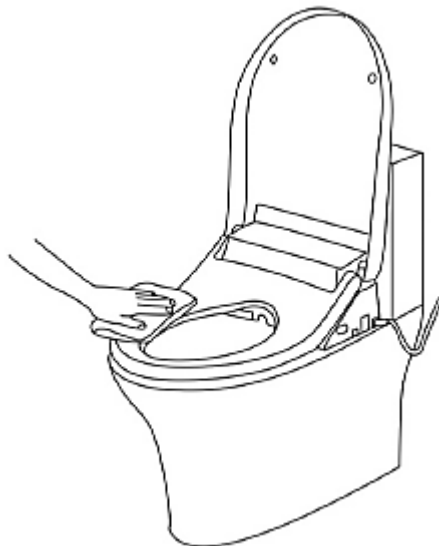

Note:

Do not pour the water on the product during maintenance.

Spray nozzle maintenance

Do the following to clean the wand.

1. Briefly press the "nozzle cleaning" or "rear cleaning" button and the wand will come out. Wipe the wand clean with a soft damp cloth.
2. Press and hold the "nozzle cleaning" button and the wand will stay inside and self-clean internally.
3. Press again "nozzle cleaning" or "stop" or "rear cleaning" button, it will stop the cleaning.
(The button function will be different according to different optional remote control)

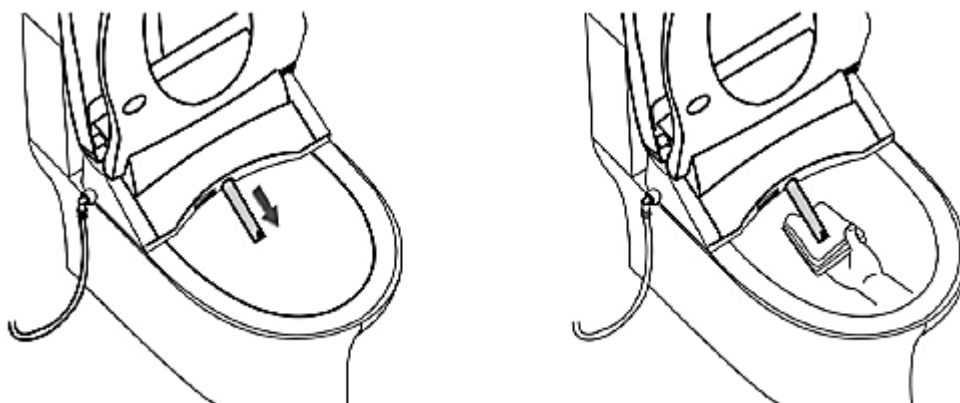

Note:

Do not apply force when pushing or pulling the wand, as this may damage the mechanism.

Inlet filter cleaning

1. Pull out electrical plug, then shut off water supply valve and remove water supply hose.
2. Remove the filter. Use a brush to clean the filter.
3. Put the filter back into inlet after cleaning. Then connect the water supply pipe.

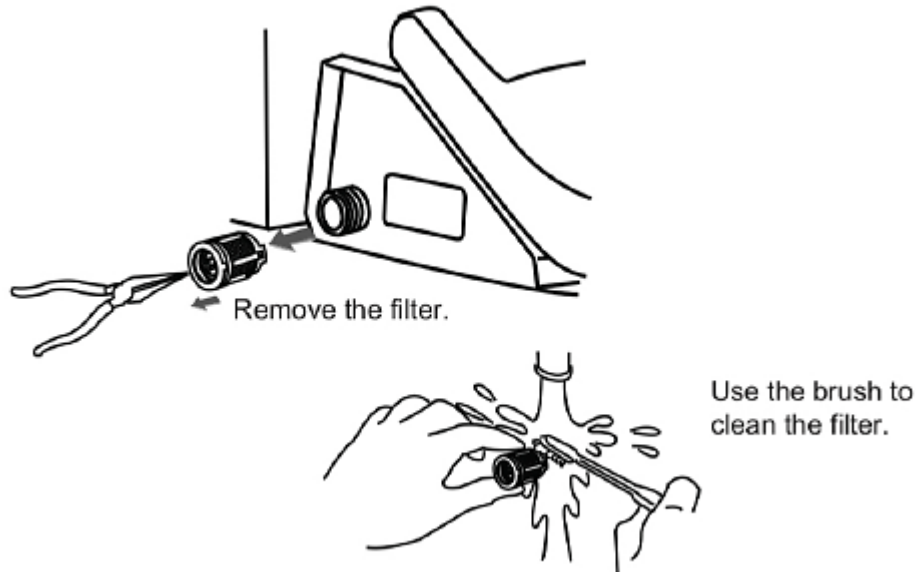

Tank anti-freezing and anti-bacterial maintenance

When room temperature is below freezing and electricity is disconnected, or user is away for a long time, the water inside the tank should be discharged.

- 1) Open the tank cover, press the discharge button, turn on valve to discharge the water.
- 2) Slightly press the discharge button protruding part to turn off discharging valve and cover

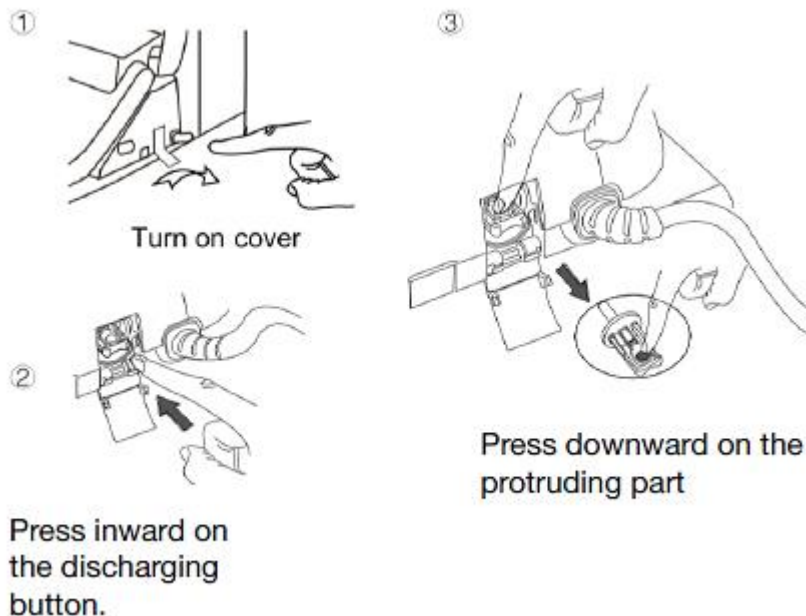

Note: Before discharging the water, the power must be cut off!

Troubleshooting Guide

Problem	Cause	Solution
Not flushing	Water supply hose is kinked	Straighten hose, remove blockage
	Angle valve is turned off	Turn on angle valve
	Water supply is cut off	Connect water supply and wait for the water
Poor flushing		
	Fill valve is not fully turned on	Turn on the fill valve fully
The water is not hot	Filter is dirty and causes blockage	Clean the filter
	Water temp is at its lowest setting	Adjust water temp on remote
Seat temperature is not hot	In standby mode or power save mode	Switch to function mode, and then wash after 3 minutes
	Seat temp is set to lowest setting	Adjust seat temp on remote
Dryer air not hot	In standby mode	Shift to function mode for 3 minutes
	Dryer temp is at its lowest setting	Adjust dryer temp on remote
No air coming out of dryer	Dryer temp is at its lowest setting	Adjust dryer temp on remote
Spray wand not retracting	In standby mode or power save mode	Shift to function mode to use dry function
	Power may be off	Push back the wand lightly and wait for the power
Spray wand not	May have debris or clog	Clean wand
	Power may be off	Push back the wand lightly and wait for the power
Display on remote not working	Sensor may not be activated.	Make sure you're fully on seat.
	Batteries may be low	Replace batteries
 Caution	If the problems cannot be solved as per above methods, please shut-off the power, and contact service providers for maintenance.	
	If the leakage circuit breaker often trips off, it means the products has electricity leakage, so please shut-off the power, and contact service provider for maintenance.	

WARRANTY- Please refer to www.myluxyloo.com to register your product